

TRADITIONAL DIAL INDICATORS, GROUP 2-CONTINUED

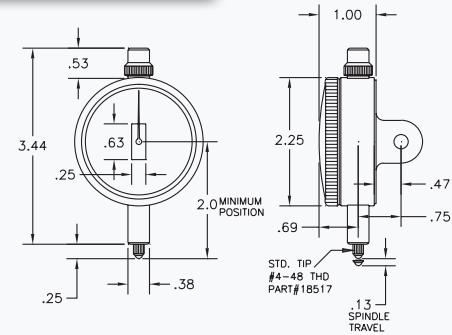

MODEL	2DM005-002mm	2DM012-005mm	2DM5-01mm	2DM10-01mm	2DM25-01mm
Graduation	0.002mm	0.005mm	0.01mm	0.01mm	0.01mm
Total Travel	.5mm	1.25mm	5mm	10mm	25mm
Revolutions	2.5 Rev.	2.5 Rev.	5 Rev.	10 Rev.	25 Rev.
Travel/Rev.	0.200mm	0.50mm	1.0mm	1.0mm	1.0mm

BACK OPTIONS FOR GROUP 2

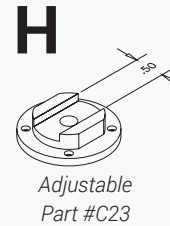
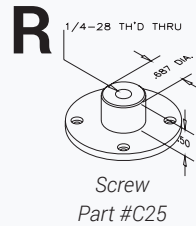
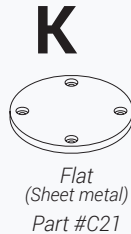
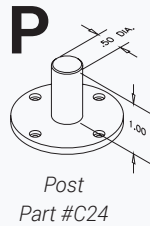
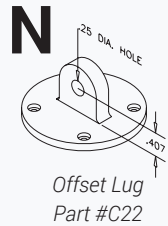
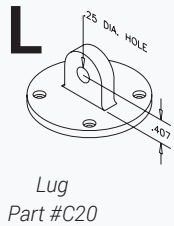

The letter designating the indicator back follows the letter designating the dial format.

Example #1: 2I50-01B

H

Example #2: 2DM100-01B

H

See page 14 for dial face options, 15 for accessories and contacts

GROUP 1 TRADITIONAL DIAL INDICATORS

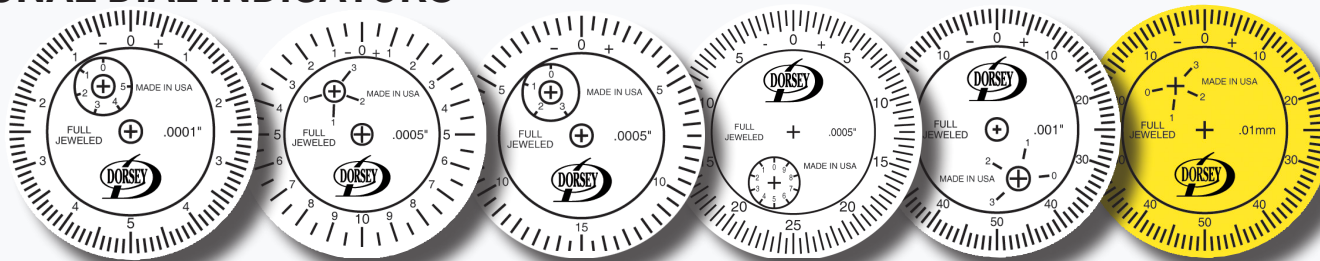

MODEL	1DM025-01	1DM050-05	1DM075-05	1DM125-05	1DM250-10	1DM2-01mm
Graduation	.0001"	.0005"	.0005"	.0005"	.001"	0.01mm
Total Travel	.025"	.050"	.075"	.125"	.250"	2.5mm
Revolutions	2.5 Rev.	2.5 Rev.	2.5 Rev.	2.5 Rev.	2.5 Rev.	2.5 Rev.
Travel/Rev.	.010"	.020"	.030"	.050"	.100"	1.0mm